

Typ výplně Styl 10.14

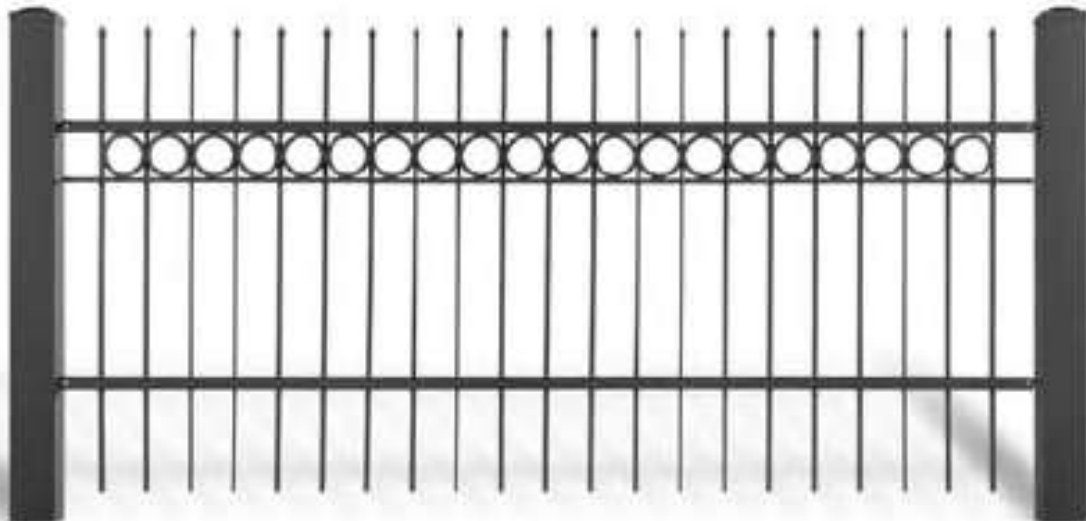

- konstrukce z ocelových profilů 12x12 mm

- základní povrchová úprava žárovým zinkem, nebo žárový zinek a prášková barva

- dílec s horní úrovní rovný, konklávní nebo do oblouku

Doplňková výbava :

Barevné provedení

Zakončení hroty

Plotový díl typizovaný rozměr

Rozměry (š x v) [mm]

2 500 x 900, 1 200, 1 450 mm

3 000 x 900, 1 200, 1 450, 1 750 mm

Speciální zákaznický rozměr

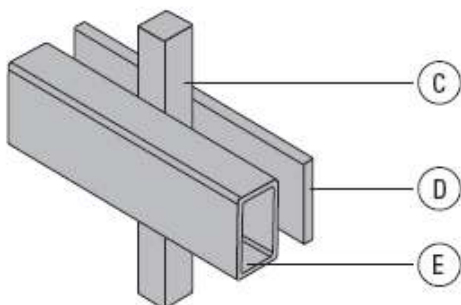

(S) 2500 [mm] x (H) 900 [mm] - 47 kg	(S) 3000 [mm] x (H) 1200 [mm] - 66 kg
(S) 2500 [mm] x (H) 1200 [mm] - 54 kg	(S) 3000 [mm] x (H) 1450 [mm] - 74 kg
(S) 2500 [mm] x (H) 1450 [mm] - 61 kg	
max: (S) 3000 [mm] x (H) 1750 [mm]	

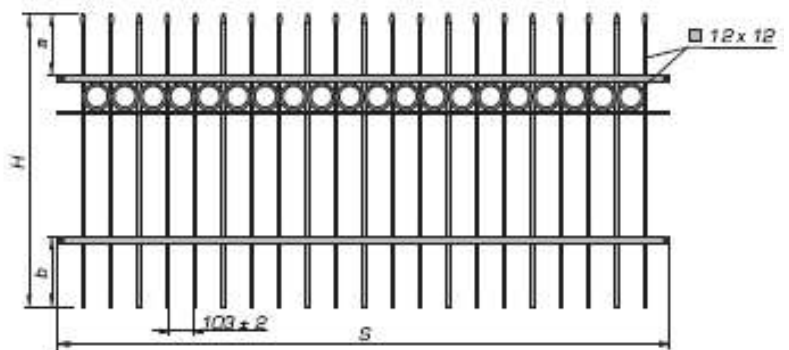

$H \geq 1000$: a=250, b=300, $H_{min}=800$	$800 \leq H < 1000$: a=250, b=200, $H_{min}=800$
---	---

(S) 2500 [mm] x (H) 900 [mm] - 45 kg	(S) 3000 [mm] x (H) 1200 [mm] - 64 kg
(S) 2500 [mm] x (H) 1200 [mm] - 52 kg	(S) 3000 [mm] x (H) 1450 [mm] - 72 kg
(S) 2500 [mm] x (H) 1450 [mm] - 59 kg	
max: (S) 3000 [mm] x (H) 1750 [mm]	

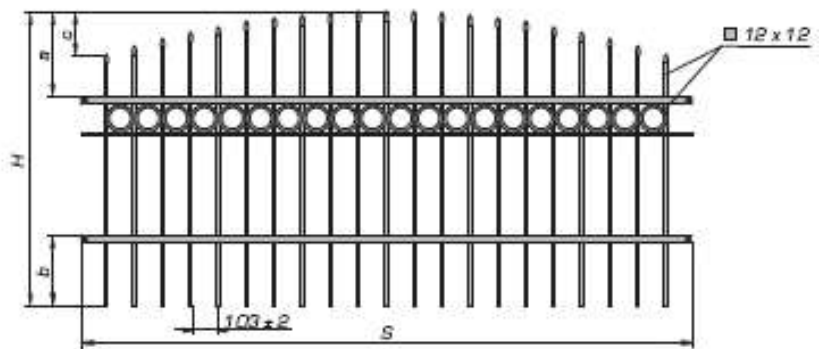

$H \geq 1100$: a=350, b=300, c=175, $H_{min}=900$	$900 \leq H < 1100$: a=350, b=200, c=175, $H_{min}=900$
--	--

Vchodová branka

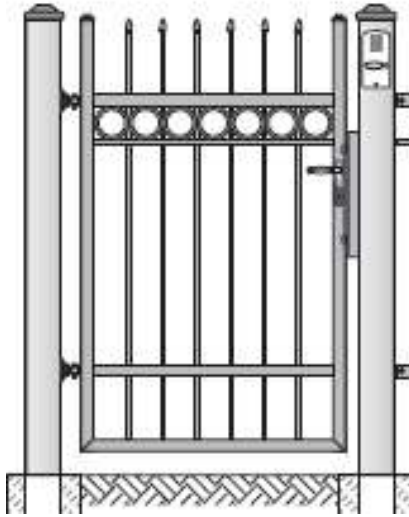

(S) 2500 [mm] x (H) 900 [mm] - 45 kg	(S) 3000 [mm] x (H) 1200 [mm] - 64 kg
(S) 2500 [mm] x (H) 1200 [mm] - 52 kg	(S) 3000 [mm] x (H) 1450 [mm] - 72 kg
(S) 2500 [mm] x (H) 1450 [mm] - 59 kg	
max. (S) 3000 [mm] x (H) 1750 [mm]	

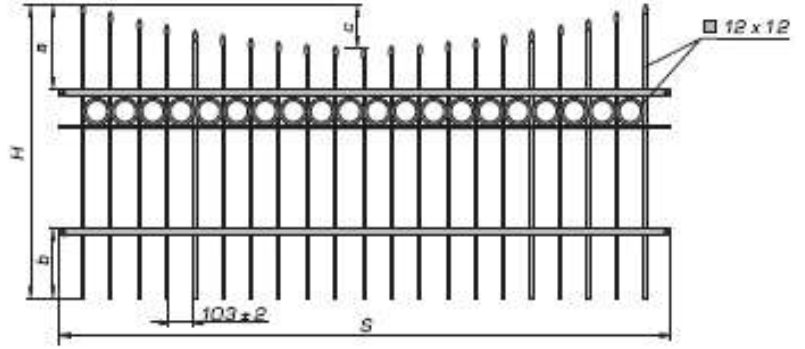

$H \geq 1100$: a=350, b=300, c=175, $H_{\text{net}}=900$	$900 \leq H < 1100$: a=350, b=200, c=175, $H_{\text{net}}=900$
---	---

Dvoukřídlová brána

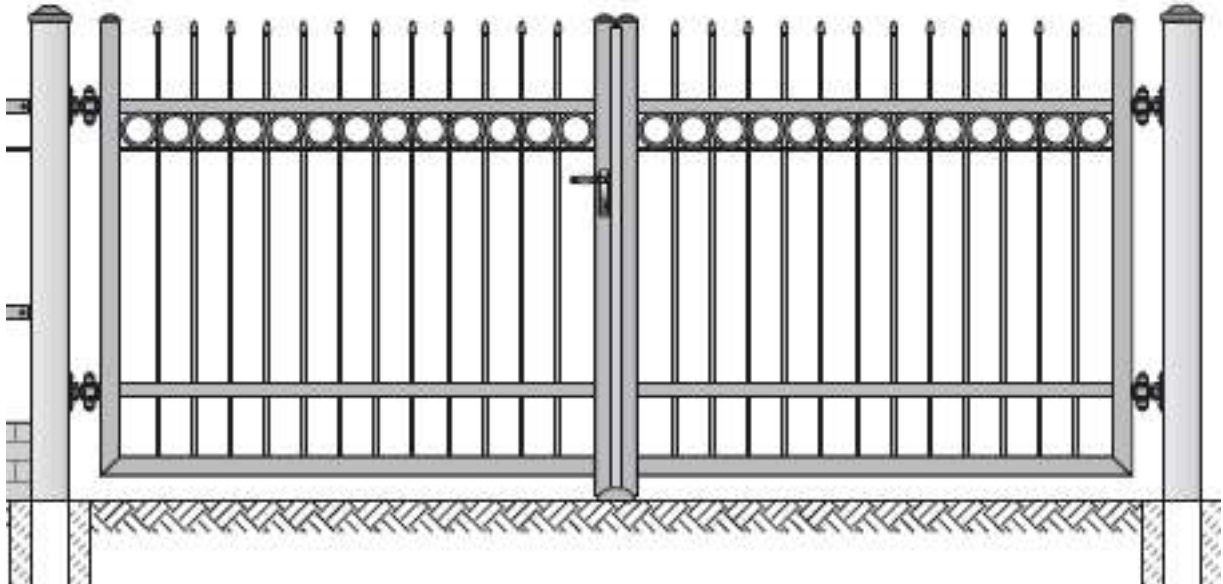

Samonosná brána

